

For Undermount Slide 19mm

Height 90

Height 128

Height 175

Back Installation Dimensions

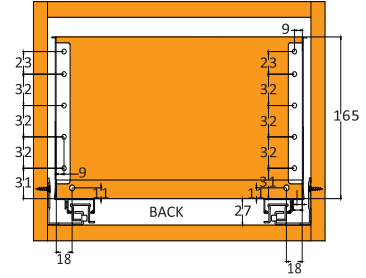
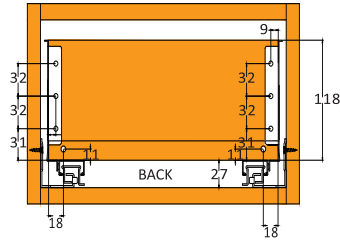
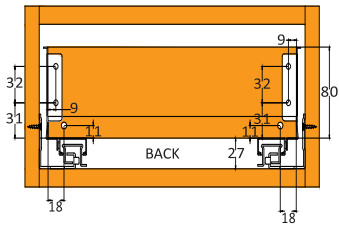

Front Installation Dimensions

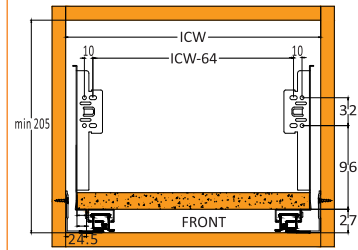
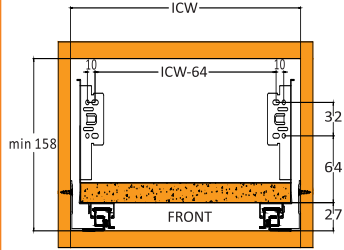
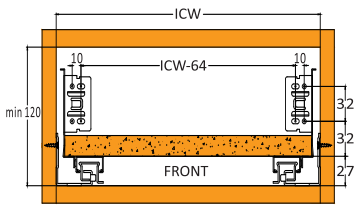

Cutting Dimensions for Back & Bottom Panel

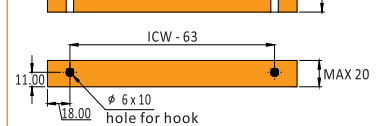
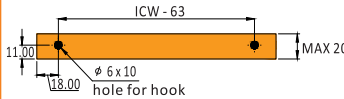
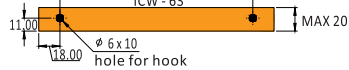
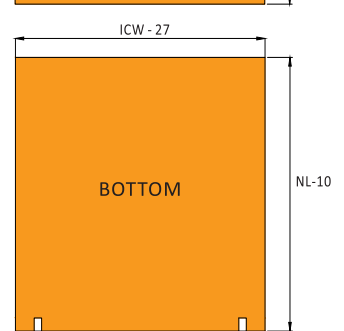
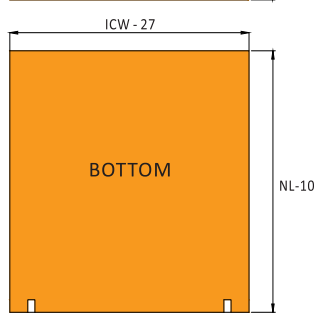
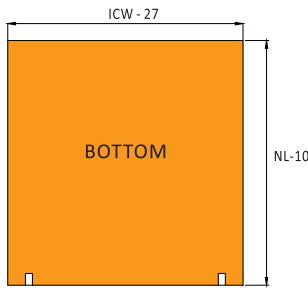
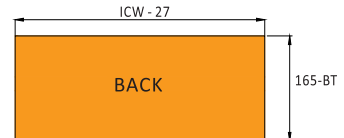
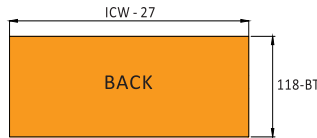
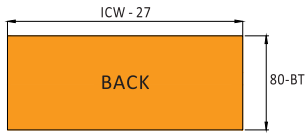

- *NL = Nominal Length
- *BT = Board Thickness
- *ICW = Internal Cabinet Width

Panel assembly

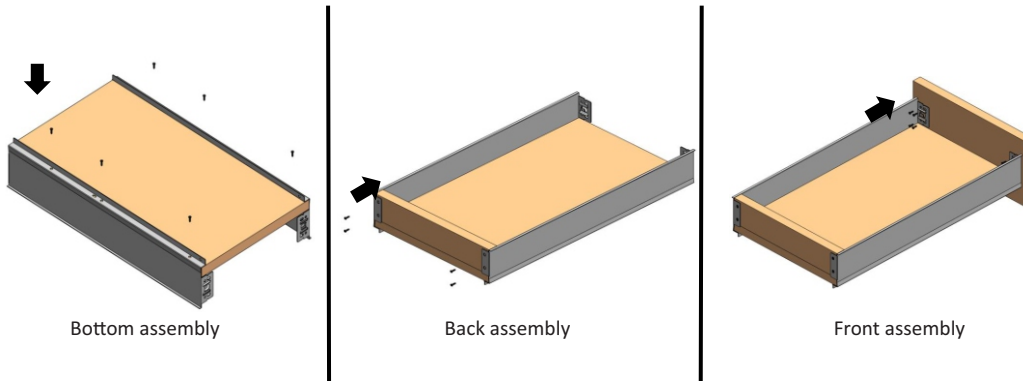

Adjustment Direction & Tolerance

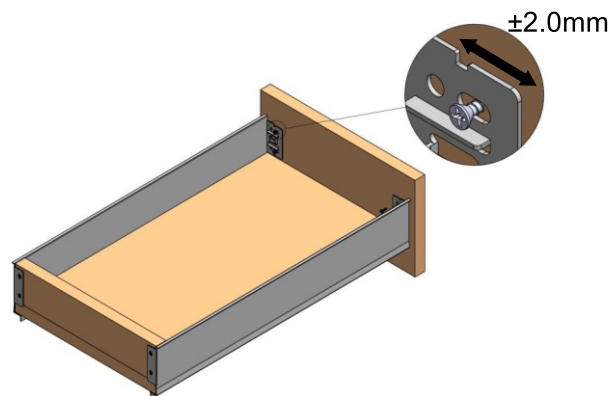

Cover Cap Assembly & Removal

